















Vis Trompette pour Plaque de Plâtre

Vis Trompette Standard			Vis Trompette Filet Profond (Bois)			Vis Trompette Autoperceuse		
								
Référence	Matière	Finition Empreinte	Référence	Matière	Finition Empreinte	Référence	Matière	Finition Empreinte
0189 0	Acier Phosphaté	PH 2	0189	Acier Phosphaté	PH 2	0189 35	Acier Phosphaté	PH 2

Tige Filetée et Entretoises

Tige Filetée DIN 976-1					Tige Filetée DIN 976-1						
											
Réf.	Matière	Finition	Résist.	Longueur	Filetage	Réf.	Matière	Finition	Résist.	Longueur	Filetage
0950	Acier Brut		4.6	1 mètre	Iso	0958	Acier Zingué		4.6	1 mètre	Iso
Tige Filetée DIN 976-1					Tige Filetée DIN 976-1						
											
Réf.	Matière	Finition	Résist.	Longueur	Filetage	Réf.	Matière	Finition	Résist.	Longueur	Filetage
0959	Acier Bichomaté		8.8	1 mètre	Iso	0959 9	Acier Zingué		8.8	1 mètre	Iso
Tige Filetée DIN 976-1					Tige Filetée DIN 976-1						
											
Réf.	Matière	Finition	Longueur	Filetage	Réf.	Matière	Finition	Longueur	Filetage		
0954	Inox A2 (18/10)		1 mètre	Iso	0953	Inox A4 (18/12)		1 mètre	Iso		
Entretoise Hexagonale Taraudée											
											
Référence	Matière Finition										
0974	Acier Zingué										

Données Techniques Vis Trompette pour Plaque de Plâtre

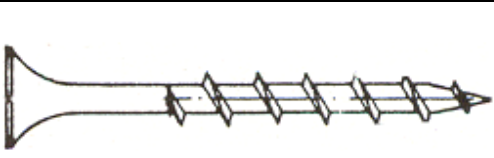
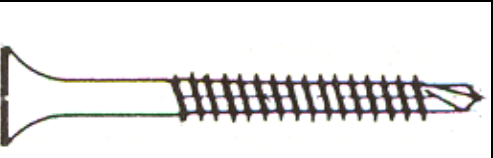
 <p>Vis Trompette Standard</p>			 <p>Vis Trompette Filet Profond (Bois)</p>			 <p>Vis Trompette Auto-perceuse</p>		
Référence	Matière Finition	Empreinte	Référence	Matière Finition	Empreinte	Référence	Matière Finition	Empreinte
0189 0	Acier Phosphaté	PH 2	0189	Acier Phosphaté	PH 2	0189 35	Acier Phosphaté	PH 2
Diamètre filetage (d1) en mm			Diamètre filetage (d1) en mm			Diamètre filetage (d1) en mm		
3,9, 4, 5			3,9, 4, 5			3,5		

Données Techniques Tige Filetées et Entretoises

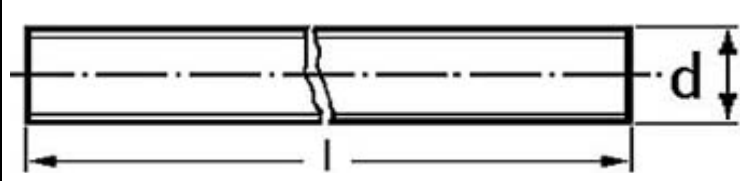
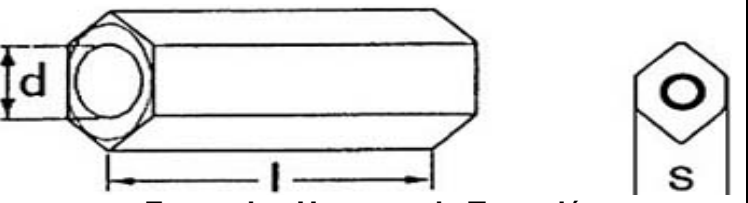
 <p>Tige Filetée DIN 976-1 (Barres de 1 mètre)</p>					 <p>Entretoise Hexagonale Taraudée</p>					
Réf.	Matière Finition	Résist.	Filetage	Longueur	Référence	Matière Finition				
0950	Acier Brut	4.6	Iso	1 mètre	0974	Acier Zingué				
0958	Acier Zingué	4.6	Iso	1 mètre	Diamètre filetage (d1) en mm		6	8	10	12
0959	Acier Bichomat	8.8	Iso	1 mètre	Diamètre surplat (s) en mm		10	11	13	17
0959 g	Acier Zingué	8.8	Iso	1 mètre						
0954	Inox A2 (18/10)		Iso	1 mètre						
0953	Inox A4 (18/12)		Iso	1 mètre						